



IZERWAREN
Order
numbers

- Seawater Resistant
- Finish: Satin nickel plated

MINI INVISIBLE HINGES WITH STAINLESS STEEL PINS



invisible hinge for minimum door thickness 1/2"

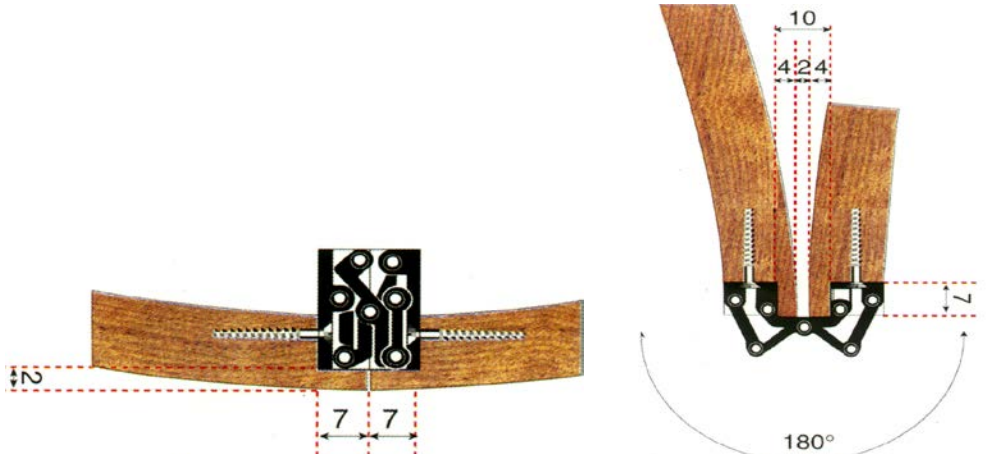
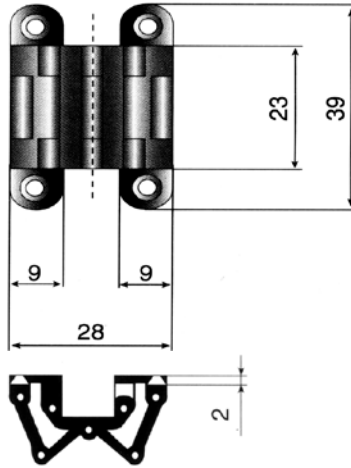

Small Invisible Hinge 41.039, minimum door thickness 1/2"

41.039 **Invisible hinge**
 For cabinet doors
 Dimensions: 28 x 39 x 9 mm
 Minimum door thickness: 11 mm or 1/2"
 180 degree opening

41.088 **Invisible hinge**
 For medium weight doors: 50 to 22 lbs using 2 hinges
 88 x 18 x 13 mm ~
 Minimum door thickness: 24 mm
 180 degree opening



41.041



41.052

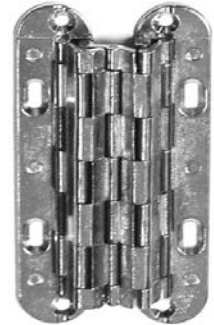

41.088

SEPA hinge for door thickness from 24 mm to 35 mm or 1" to 1 1/4"

41.052 **Invisible hinge**
 For medium to light doors: 40 to 22 lbs using 2 hinges
 52 x 18 x 13 mm ~
 Minimum door thickness: 24 mm
 180 degree opening

41.041 **Invisible hinge**
 For light doors: 22 lbs using 2 hinges
 41 x 18 x 13 mm ~
 Minimum door thickness: 24 mm
 180 degree opening

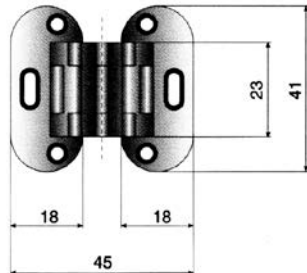

41.041

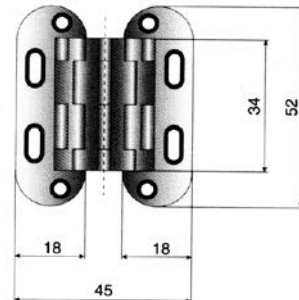

41.052

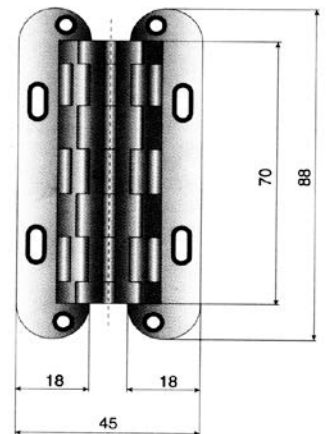

41.088



Izerwaren
Order
numbers

41.204 "SOSS" type invisible hinge

Size hinge:
L: 2 3/8 inch x W: 1 3/8 inch
Door thickness: 3/4 inch
180 degree opening
Finish: 316 satin stainless steel

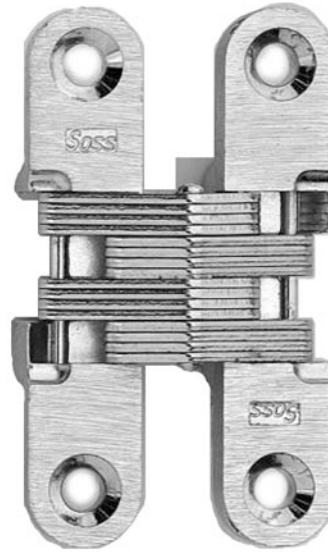
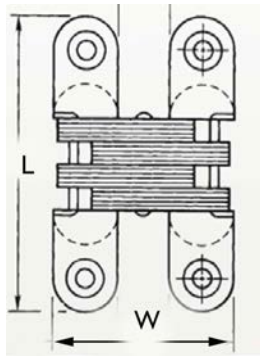

#41.204 Invisible Hinge, minimum door thickness 3/4 inch

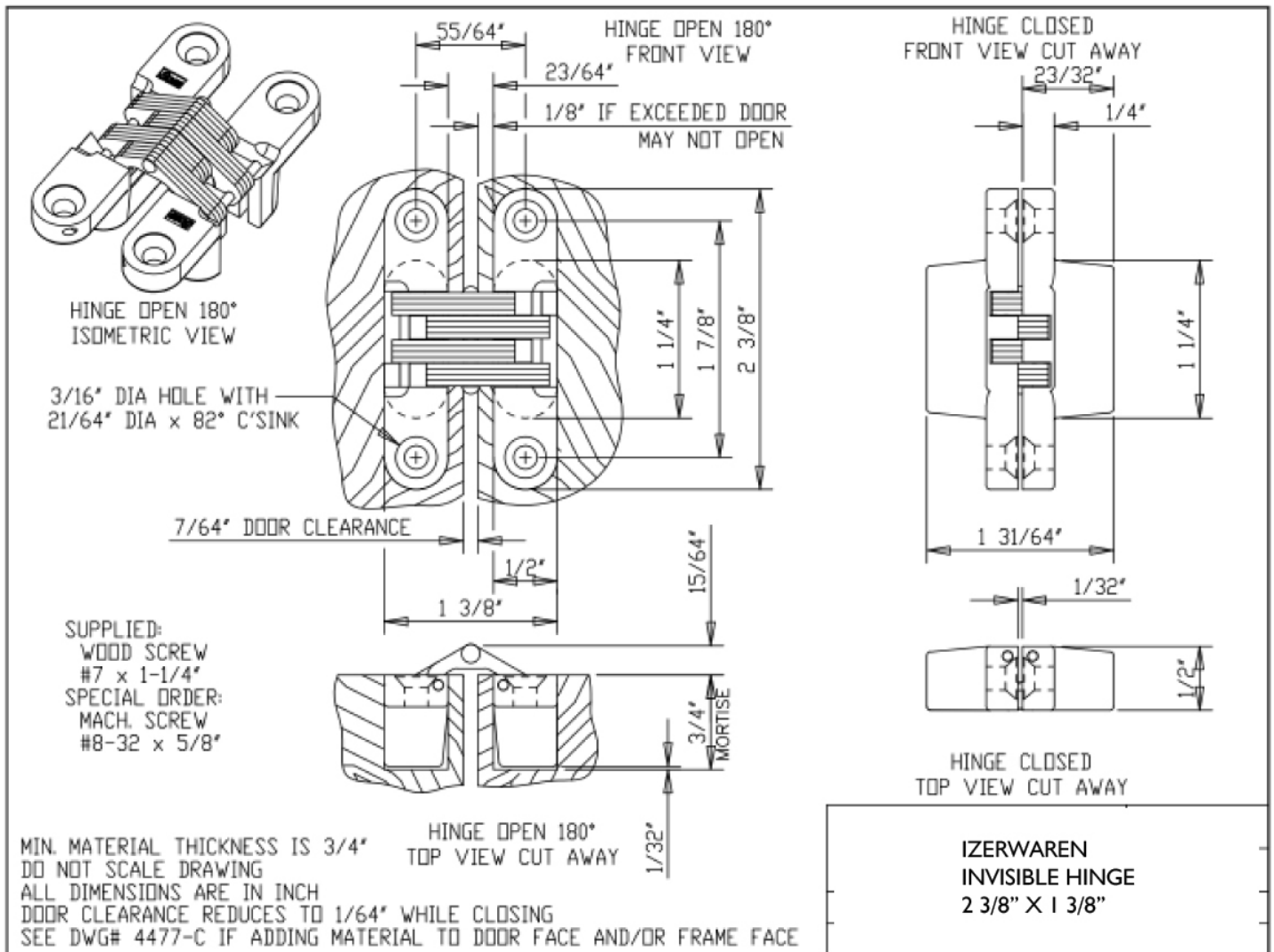



Izerwaren
Order
number

41.101 "SOSS" type invisible hinge

Size hinge:
L: 1 11/16 inch x W: 1 3/64 inch
Door thickness: 5/8 inch
180 degree opening
Finish: 316 satin stainless steel
Max. Door weight: 7 kg / 15.4 lbs
using 3 hinges
Finish: 316 satin stainless steel

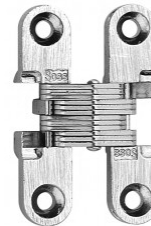
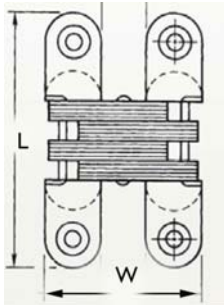

#41.101 Invisible Hinge, minimum door thickness 5/8 inch.

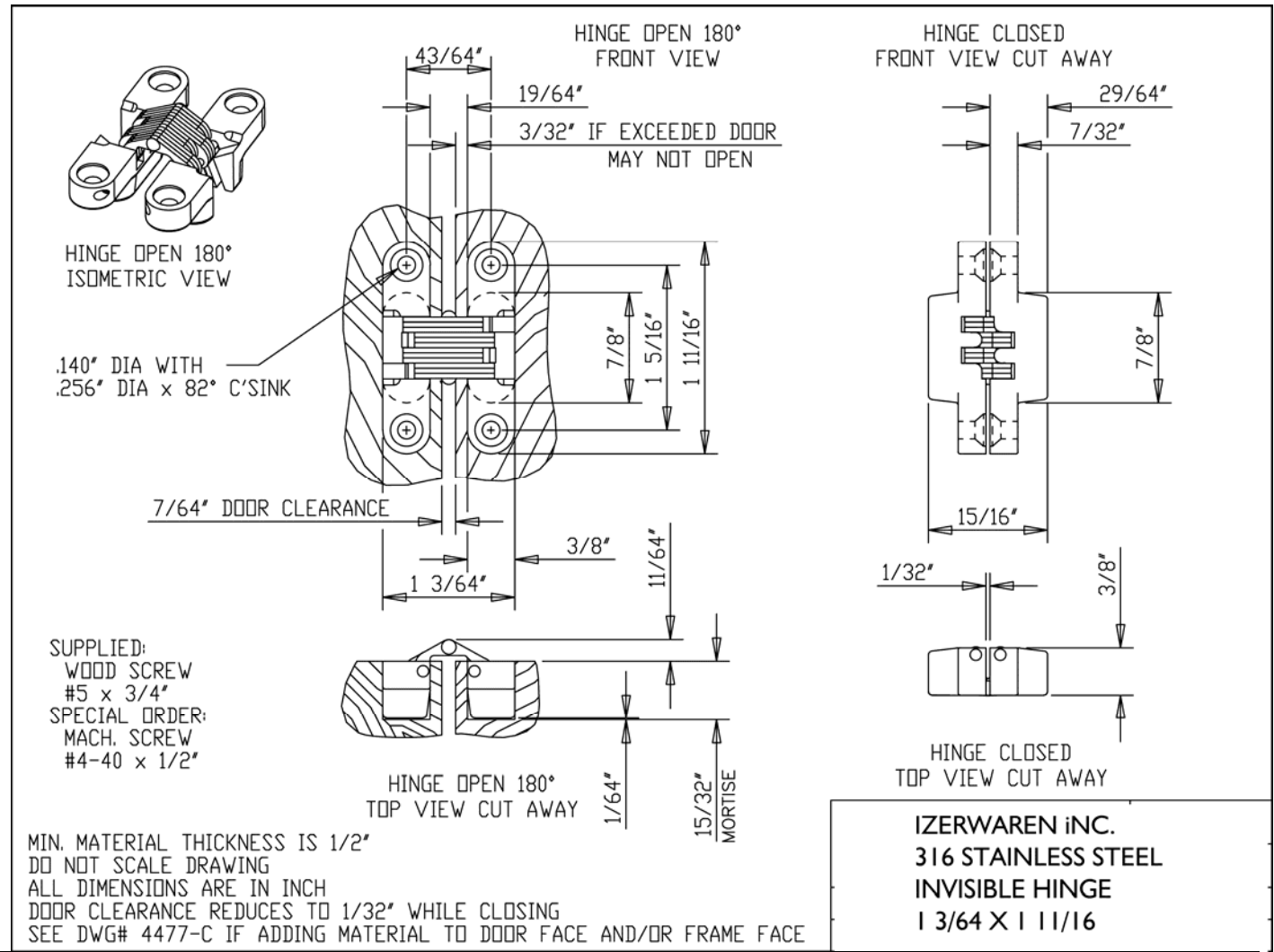



Izerwaren
Order
numbers

42.200 **Easy on hinge** (2000) 304 stainless steel
42.20S **Easy on hinge** (2000S) spring loaded

For overlay, half overlay or insert doors.

Door thickness: 3/4" or 20 mm

Dimensions: Open: 4 1/16" L x 1 3/4"W

The spring loaded version has an electroplated hardened steel spring.

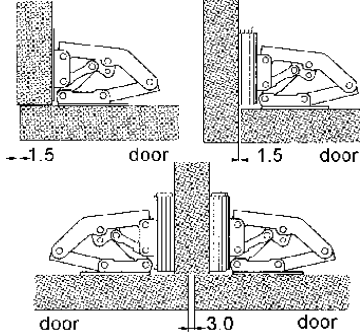

Installation:

Easy and quick installing non mortise cabinet hinge, no machining. Self closing and self locking. (spring loaded version)

Use filler plates when installing half overlay or insert doors

42.001 White nylon filler plates (2001)
Filler plates thickness: 1/16" thick
For 2000 model only

304 STAINLESS STEEL EASY ON HINGE LIGHT DUTY

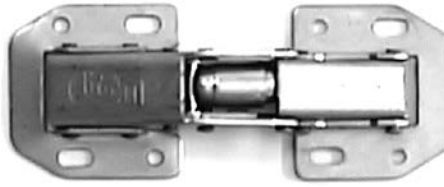

#42.20S 90 degree stainless steel "easy on hinge",

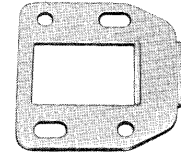

#2001 filler plate

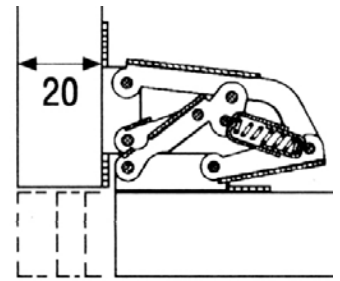
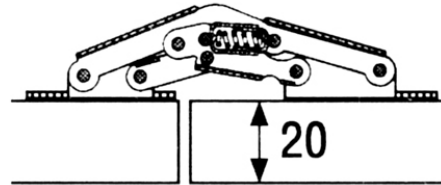
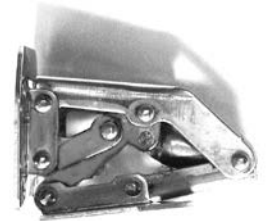

Leave 1.5 mm 1/16" gap when installing insert doors and full overlay.
Leave 3 mm 1/8" gap when installing 2 doors back to back half overlay. For 3/4" thick material

90 DEGREE OFFSET STEEL GALVANISED STEEL EASY ON HINGE

Offset type hinge.
42.0F0 **Easy on hinge** (2000F) not spring loaded
42.0FS **Easy on hinge** (2000FS) spring loaded
For overlay doors.
90 degree opening, door swings out.
Galvanized steel.

Door thickness: 3/4" or 20 mm

Dimensions: Open: 4 1/16" L x 1 3/4"W

Self closing and self locking = (spring loaded version)

The spring loaded version has an electroplated hardened steel spring.



#42.0F0 90 degree offset galvanized steel "easy on hinge", spring loaded hinge

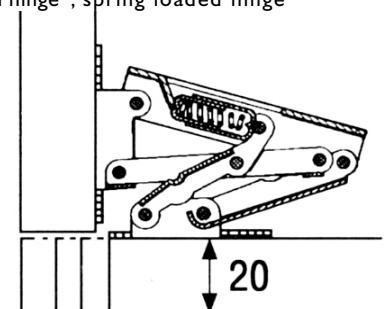
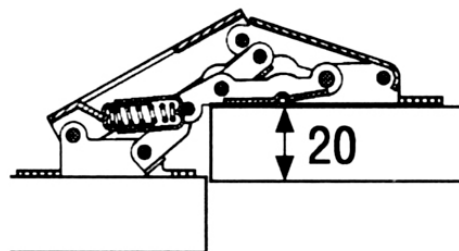

Leave 1.5 mm 1/16" gap when installing insert doors and full overlay. For 3/4" thick material



Izerwaren Stronger than regular "Euro" hinges
Order numbers

42.150 **Easy on hinge** (2000/150) not spring loaded
42.15S **Easy on hinge** (2000/150S) spring loaded
150 degree opening,
For overlay, half overlay or insert doors.
Dimensions: Open: 5 3/16" L x 2 1/16" W
Required door thickness: 3/4" or 20 mm
The spring loaded version has an electroplated hardened steel spring.
Installation:
Easy and quick installing non mortise cabinet hinge, no machining. Self closing and self locking. (spring loaded version)

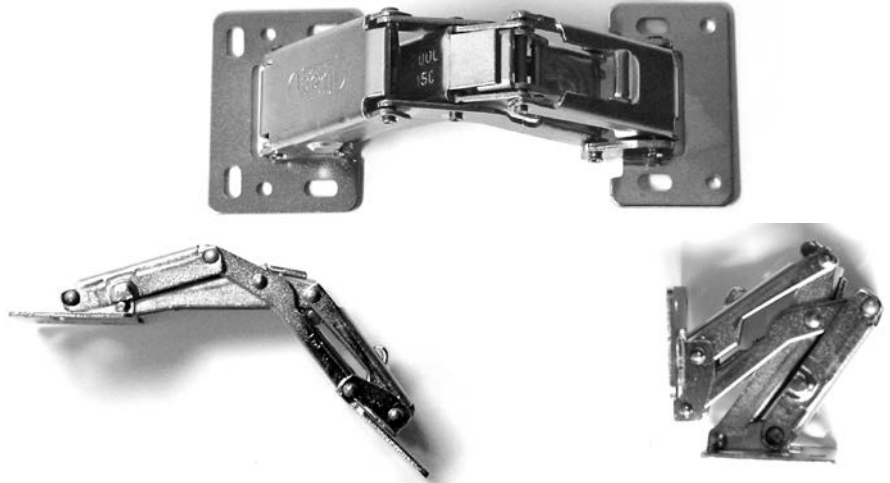

#42.150S 150 degree galvanized steel "easy on hinge", spring loaded hinge

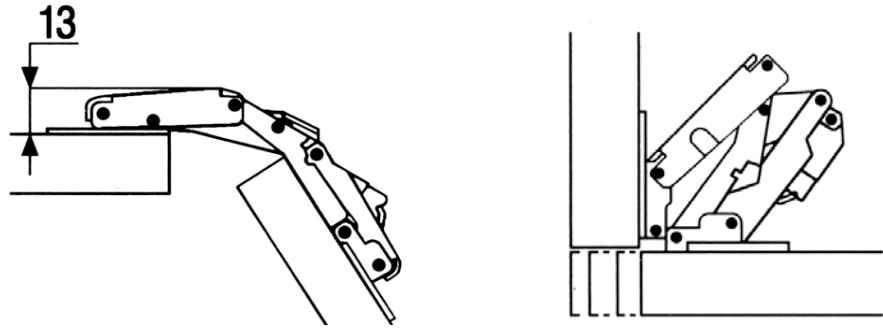

42.170 **Easy on hinge** (2000/170) not spring loaded
42.17S **Easy on hinge** (2000/170S) spring loaded
170 degree opening,
For overlay, half overlay or insert doors.
Dimensions: Open: 6 1/4" L x 2" W
Required door thickness: 3/4" or 20 mm
The spring loaded version has an electroplated hardened steel spring.
Installation:
Easy and quick installing non mortise cabinet hinge, no machining. Self closing and self locking. (spring loaded version)

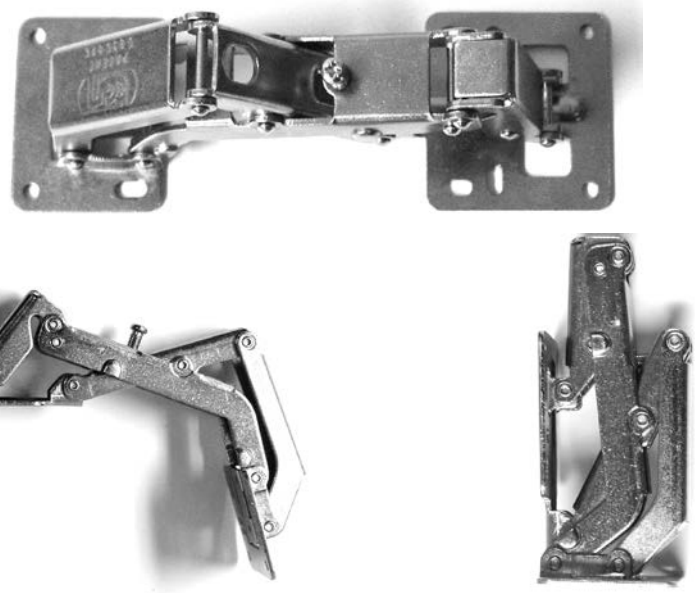

#42.17S 170 degree galvanized steel "easy on hinge", spring loaded hinge

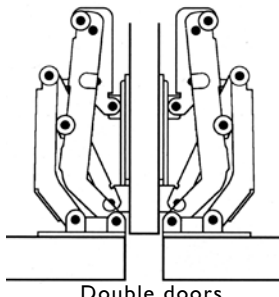

Double doors

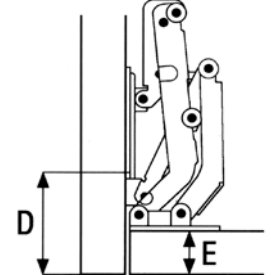

D = Maximum 44 mm
E = Maximum 20 mm

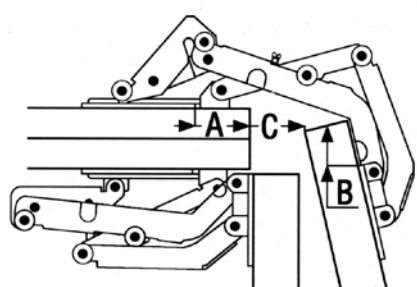

A = fixed at 24 mm C = distance 24 mm
B = adjustable from 0 to 20 mm



Izerwaren
Order
numbers

42.7753 **Invisible on hinge for cabinet doors
or small deck hatches**
316 polished stainless steel
125 degree opening
For inlay or up lay doors
Load: Max. 12 lb per hinge
12/19 mm door thickness

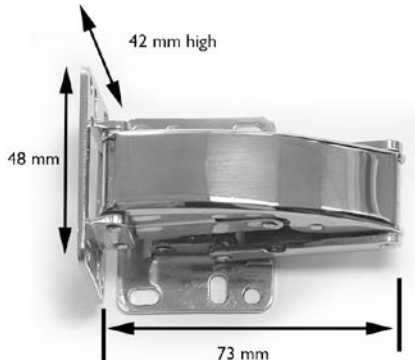

#42.7753 Easy On hinge;
Closed dimensions in mm: 73 long x 42 high x 48 wide

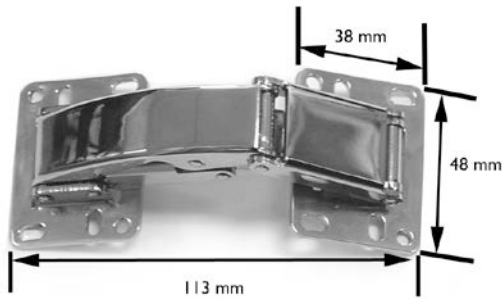

Open dimensions in mm: 113 long x 48 wide
Footprint hinge plates: 48 x 38 mm

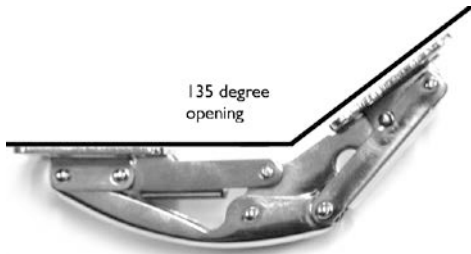

135 degree max. angle on hinge

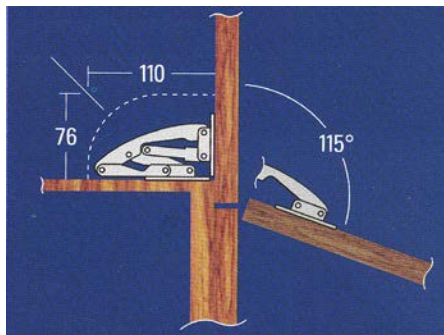

resulting in 125 degree opening door for the
small hinge 42.7753. Bigger size hinges
open 115 degree.

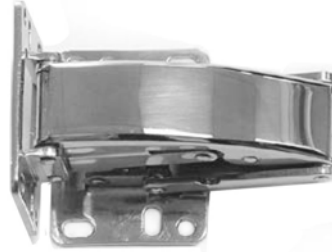

#42.7753 Easy On hinge; 135 degree 316 polished stainless steel



Easy on hinge closed: 73 x 62 x 2 mm thick.
Footprint: 48 x 38 mm.



#42.7753; 125 degree 316 stainless steel easy on hinge



Half way open/ offset



125 degree fully open



42.7753 Small: Max. load:
12 lb per hinge.

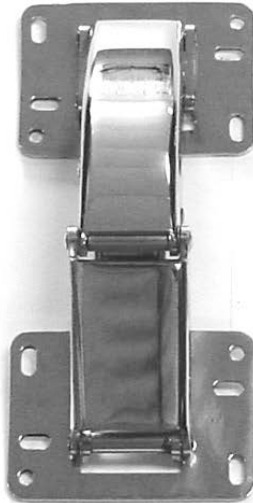

42.8865 Medium: Max. load:
50 lb per hinge.

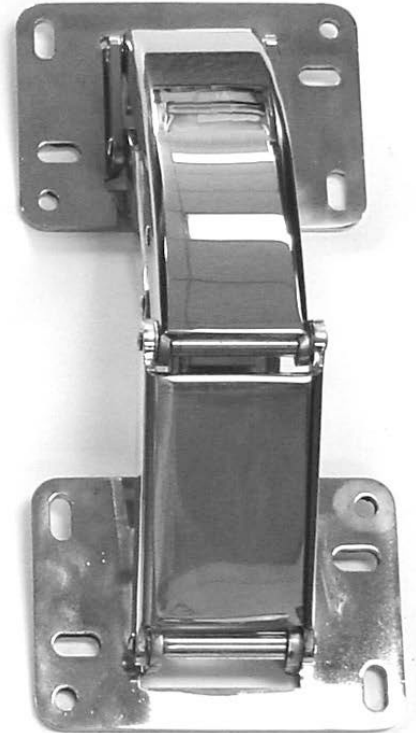

42.7755 Big: Max. load:
75 lb per hinge.

“EASY ON” HINGE FOR HATCHES, BULWARK DOORS AND CABINET DOORS.

* 316 polished stainless steel

* 115 degree opening

* For inlay and up lay doors

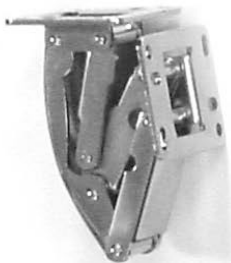

Size 3 x 2 5/8 inch

Size 4 1/4 x 2 1/2 inch

Size 6 7/8 x 3 3/4 inch

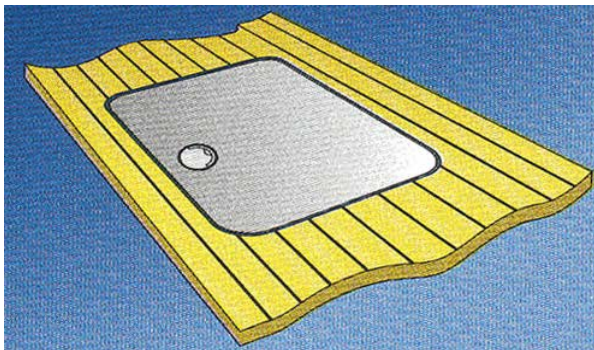

Closed position

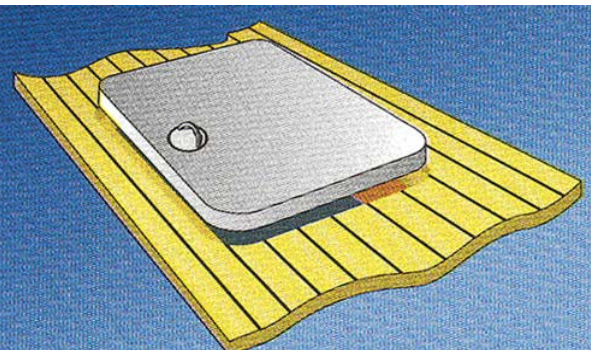

Lifts up first then out

with lift ring #44.0980 with cam

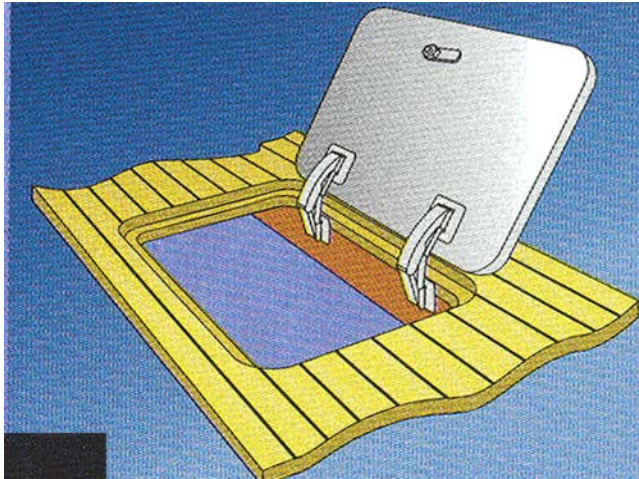

Opens 115 degree

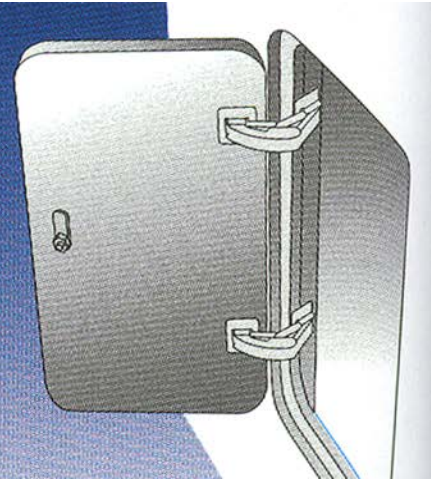

Opens 115 degree

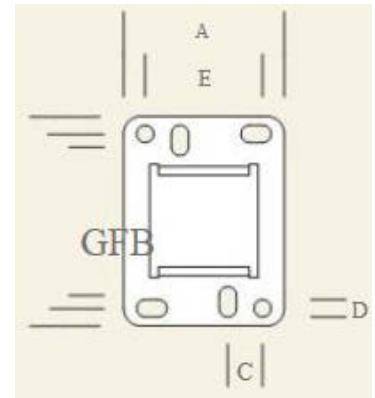
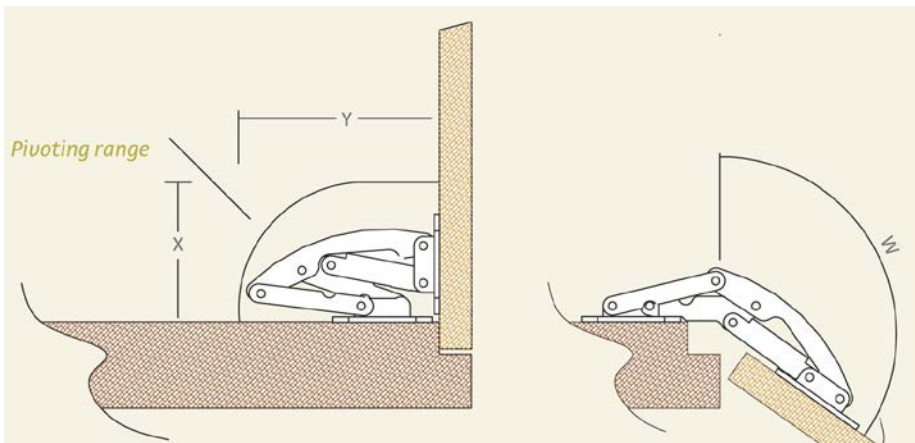

Footprint layout

Art	A	B	C	øD	E	F	G	t	W	X	Y
42.7753	37	48	8	4	27	40	34	max. 12	125°	52	75
42.8865	57	80	12	5	37	68	58	max. 20	115°	85	115
42.7755	85	120	18	7	65	100	84	max. 30	115°	130	175

B = length mounting plate
 F = center to center screw hole
 G = distance adjusting screw hole
 t = max. thickness of door

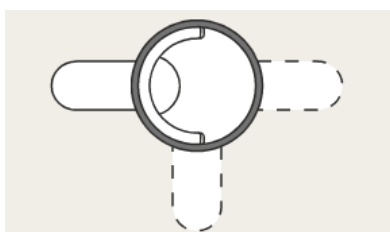

#44.0980 hatch fastener with cam and lift ring

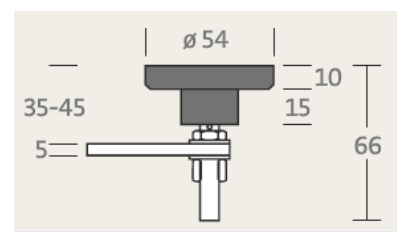



316 MIRROR POLISHED AND ELECTRO POLISHED STAINLESS STEEL

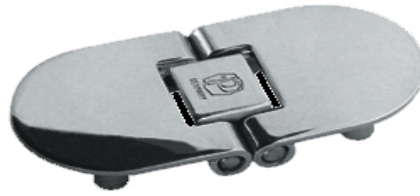

#42.638 Double barrel deck lid hinge

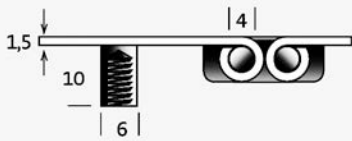

Gewindebuchsen für M4,
Material 1,5 mm
Threaded shanks for M4,
material 1,5 mm

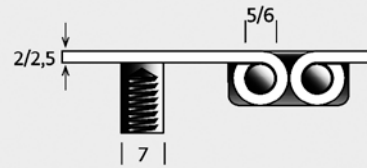

Gewindebuchsen
für M5,
Material 2/2,5 mm
Threaded shanks
for M5,
material 2/2,5 mm

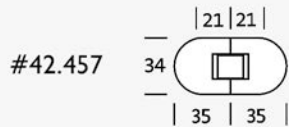

Material 2 mm
Buchsen: 12 mm lang
Material 2 mm
threaded shanks:
12 mm long

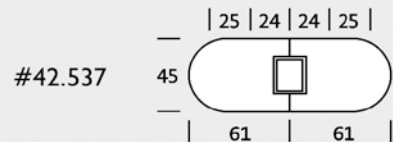
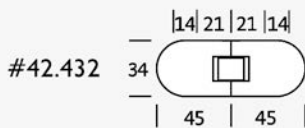
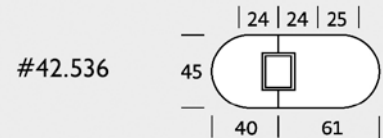
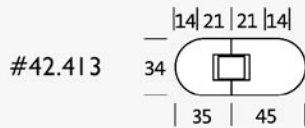
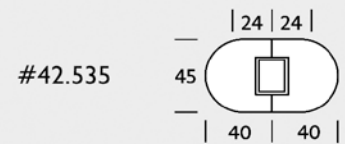

Material 2,5 mm
Buchsen: 15 mm lang
Material 2,5 mm
threaded shanks:
15 mm long

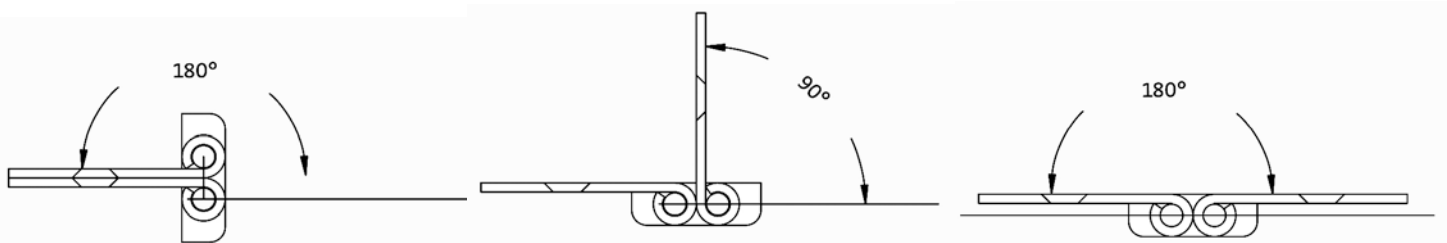
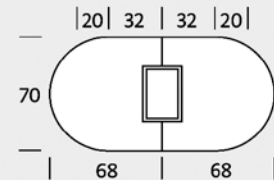



Izerwaren
Order
numbers

Hatch hinges, brass and die-cast
aluminum and stainless steel

42.255 **Hinge** each, both handed
Light duty
Polished chrome plated die-cast
Offset: $\frac{3}{4}$ " ~ 20 mm
Overall size: 60 x 52 mm

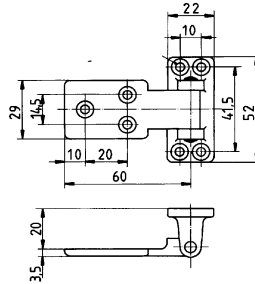

#42.255 door hinge $\frac{3}{4}$ " offset

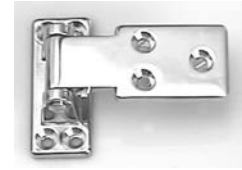

#42.255 door hinge $\frac{3}{4}$ " offset dycast



Izerwaren
Order
numbers

- Stainless steel hinges
- Sea water resistant
- Satin stainless steel

CABIN AND CABINET HINGES

Half Wide Hinges

For tall cabinet doors and small cabin doors
Non removable pin
304 stainless steel
Interior grade

	high x wide x thick	inch sizes
42.523	40 x 32 x 0.9 mm	~ 1 7/16 x 1 1/4
42.524	50 x 39 x 1.0 mm	~ 2 x 1 1/2
42.525	60 x 46 x 1.2 mm	~ 2 3/8 x 1 13/16
42.526	80 x 58 x 1.5 mm	~ 3 1/8 x 2 1/4
42.527	100 x 72 x 1.5 mm	~ 4 x 2 13/16

Half Wide Hinges - Non removable pin

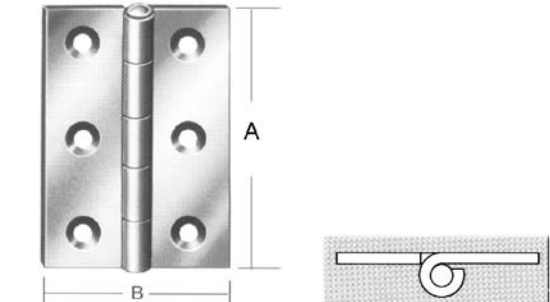

#42.52xx half wide hinge

INTERIOR GRADE 304 STAINLESS STEEL CABINET HINGES

Narrow Hinges - Non removable pin

Narrow hinges for cabinet doors

Non removable pin
304 stainless steel
Interior grade

	high x wide x thick	inch sizes
42.513	30 x 22 x 0.8 mm	~ 1 3/16 x 7/8
42.514	40 x 26 x 0.9 mm	~ 1 7/16 x 1
42.515	50 x 31 x 1.0 mm	~ 2 x 1 1/4
42.516	60 x 34 x 1.2 mm	~ 2 3/8 x 1 3/8
42.518	80 x 41 x 1.5 mm	~ 3 1/8 x 1 5/8
42.519	100 x 52 x 1.5 mm	~ 4 x 2

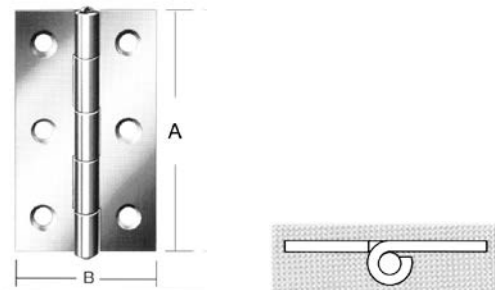

#42.51xx narrow hinge

Lift off Cabinet Hinge

304 stainless steel
Interior grade

	high x wide x thick	inch sizes
42.20050	50 x 40 x 1.5 mm Left	2 x 1 9/16
42.20051	50 x 40 x 1.5 mm Right	2 x 1 9/16

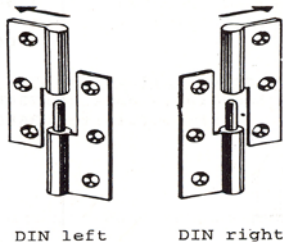

#42.20050 Left Hand lift of hinge
#42.20050 Left Hand lift of hinge



izerwaren
Order
numbers

- Brass hinges for cabinet doors
- Light duty
- NOT Sea water resistant
- Finish in stock:
- polished chrome plated brass
- other finishes are custom orders

Hinge for cabinet doors



#42.728 1 1/2" x 1 1/2"



#42.727 2" x 1 1/2"

42.728 brass butt hinge 1 1/2" x 1 1/2"
barrel 1/4" thickness 5/64"
removable pin, with finial

42.727 brass butt hinge 1 1/2" x 2"
barrel 1/4" thickness 5/64"
removable pin, with finial



#42.726 2"x2"

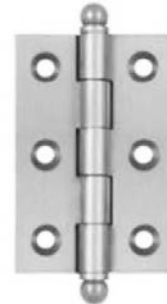

#42.725 2 1/2" x 1 1/16"

42.726 brass butt hinge 2" x 2"
barrel 1/4" thickness 5/64"
removable pin, with finial

42.725 brass butt hinge 1 3/4" x 2 1/2"
barrel 1/4" thickness 3/32"
removable pin, with finial

All hinges have ball tip finial.

42.724 brass butt hinge 2" x 2 1/2"
barrel 1/4" thickness 3/32"
removable pin, with finial

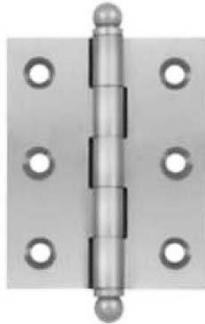

#42.724 2 1/2" x 2"



#42.723 2 1/2" x 2 1/2"

42.723 brass butt hinge 2 1/2" x 2 1/2"
barrel 1/4" thickness 3/32"
removable pin, with finial

42.722 brass butt hinge 2" x 3"
barrel 5/16" thickness 1/8"
removable pin with finial



#42.722 3" x 2"

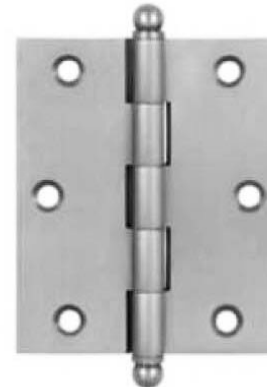

#42.721 3" x 2 1/2"

42.721 brass butt hinge 2 1/2" x 3"
barrel 5/16" thickness 1/8"
removable pin with finial

All hinges have ball tip finial.

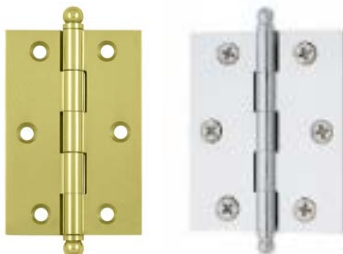

INTERIOR GRADE CABINET HINGES WITH STEEL PIN, NOT SEAWATER RESISTANT.



Finial options for cabinet and cabin door hinges

Custom order only

